

Dobler Pop-in Window | Chicane Door



Roof Top Bar - Sea Containers House, London - System S901

Features and Advantages

Advantages

- The original Dobler "Pop-in Window", also known as "Chicane Door" - well-established and proven for decades and continuously improved
- Ingenious window and door hardware - almost no maintenance required
- Straight, polygonal or radial design possible
- The Dobler "Pop-in Window" is flush with the adjacent areas when closed - it pops perfectly into the frame ("Pop-in Window")



"Pop-in Window" Alexandra Tower, Liverpool

- Barrier-free cross-sill possible
- Suitable for use in high-rise buildings, meets the most stringent security and impermeability requirements
- Also available with electric drive and BUS (Binary Unit System) control if straight design. Smart-phone apps available on request
- When open the park position can be from 0° to 90°, also in front of independent walls (e.g. brick wall)
- 90° corner sash without mullion profile in the corner
- Used to meet modern curtain wall and window requirements. Can be integrated without any visual restrictions on the frame
- Proven profile systems (Dobler/others) but project-specific designs are also possible



BUS control



Bottom detail: track with built-in grooves

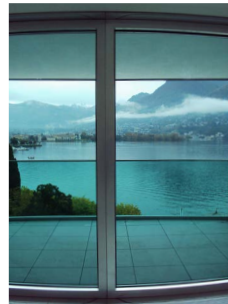

Palazzo Mantegazza, Lugano
Radial design



"Pop-in Window" - example
of a vent parked at an angle



"Pop-in Window" - Villa, Aman
Four vents in parking position

Further Positive Product Features

- Stainless steel reinforcement in the track
- Circular vulcanized gasket frame at the centre
- Dobler interlocking system with circular perforated s/s conveyor belt
- When open, parking position can be fixed glass or a vent with several functions (please refer to page 3)
- Dry glazing or SSG
- Sliding door can be integrated into a stick system as one independent unit. The vent is capable of passing the mullion, resulting in no visual restrictions in the stick system.

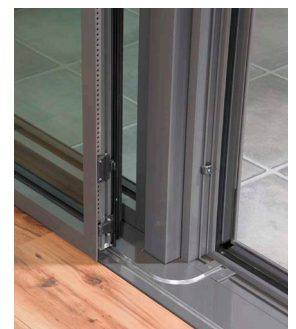
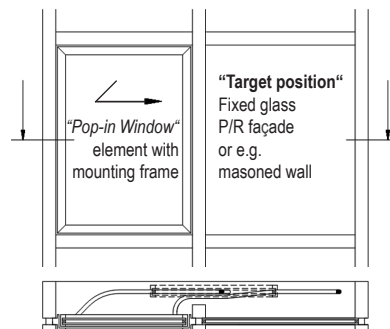

"Pop-in Window"
mode of operation in a P/R façade

- Easy one-hand operation. This ingenious system ensures straightforward movements which enable the user to handle even very heavy vents with ease.
- Faulty operation is virtually impossible due to the self guiding geometry of the track. After a push the vent slides into its final lock position.
- Horizontally arranged guiding rails which provide tracks with built-in grooves for special casters are located at the top and the bottom of each vent. Both rails can easily be integrated into the indoor floor and ceiling finish.
- Intermediate window rabbet for master vent and additional vents; guiding rails provide single tracks for each vent. The parking position of several vents can be on one side of the opening only (winter garden, patio exit). The defined closing sequence must be observed.

S901 Integrated vent - so called Dobler Block System

(Vent and fixed glass look the same from outside, the vent frame is not visible)

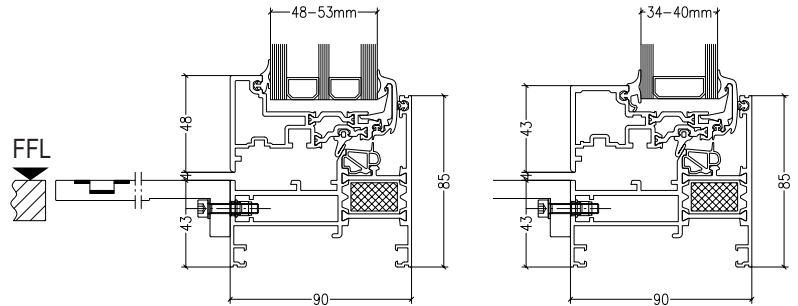
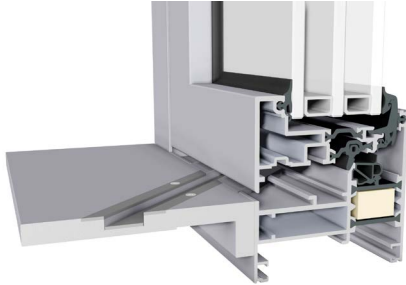

S901 Visible vent

(Vent and fixed glass look different from outside, the vent frame is visible)

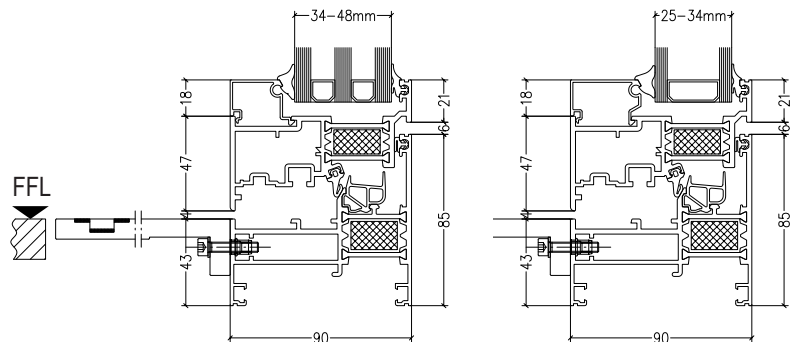
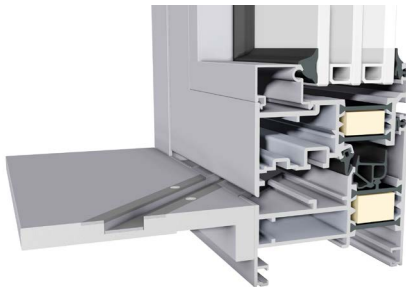

S104 Visible vent

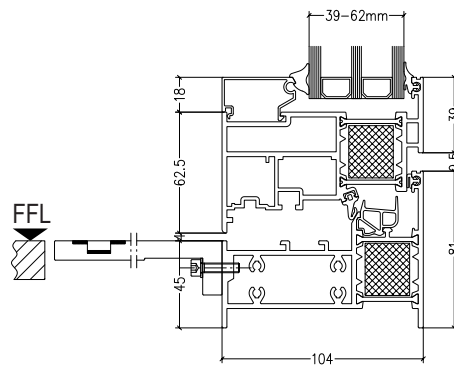



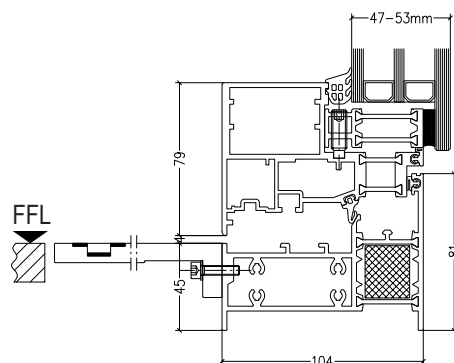
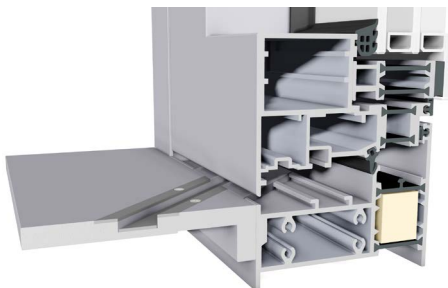





V104 Structural glazed glass



Performance Details

Performance in accordance with harmonized standard EN 14351-1: 2006 + A1: 2010

	Window system	S901 (integrated vent)	V104 (S104)	based on
	Vent sizes related to weight	Width min. 400 x max. 2700 mm Height min. 500 x max. 3000 mm	min. 400 x max. 2700 mm min. 500 x max. 3000 mm	
	Mock-up* Size of vent W x H	1300 x 2806 mm	1976 x 2692 mm	
	Max. vent weight	200 kg	260 kg	
	Air permeability	Class 4 (= 600 Pa)*	Class 4 (= 600 Pa)* (with barrier-free cross-sill)	DIN EN 12207:1999-11
	Static water penetration	Class 9A (= 600 Pa)*	Class 9A (= 600 Pa)* (with barrier-free cross-sill)	EN 12208:1999-11
	Wind resistance	Class C5/B5 (= 2000 Pa)*	Class C5/B5 (= 2000 Pa)*	EN 12210:1999-11/ AC:2002-08
	Acoustic performance (with standard cross-sill)	$R_{W,p,Glas} = 42$ dB $R_{W(C;Ctr)} = 42$ (-2,-5) dB	$R_{W,p,Glas} = 39$ dB $R_{W(C;Ctr)} = 39$ (-2,-5) dB	DIN EN ISO 140-5 DIN EN ISO 717-1
	Thermal performance Calculation value (2000 x 2180 mm)	with $U_g = 0,6$ W/(m ² K) → $U_W = 1,1$ W/(m ² K) **	with $U_g = 0,6$ W/(m ² K) → $U_W = 1,2$ W/(m ² K) *(S104)	DIN EN 10077
	Operation forces	Class 1 = 100 N **	Class 1 = 100 N **	EN 13115
	Sustainability	Class 2 = 10 000 Zyklen	Class 2 = 10 000 Zyklen	EN 12400

The following Features can be customized on request:



Specifications marked with * refer only to the mock-up with given dimensions consisting of one vent and one fixed glass
Specifications marked with ** refer only to internal tests and theoretical appraisals/calculations

Opening functions and parking positions ***

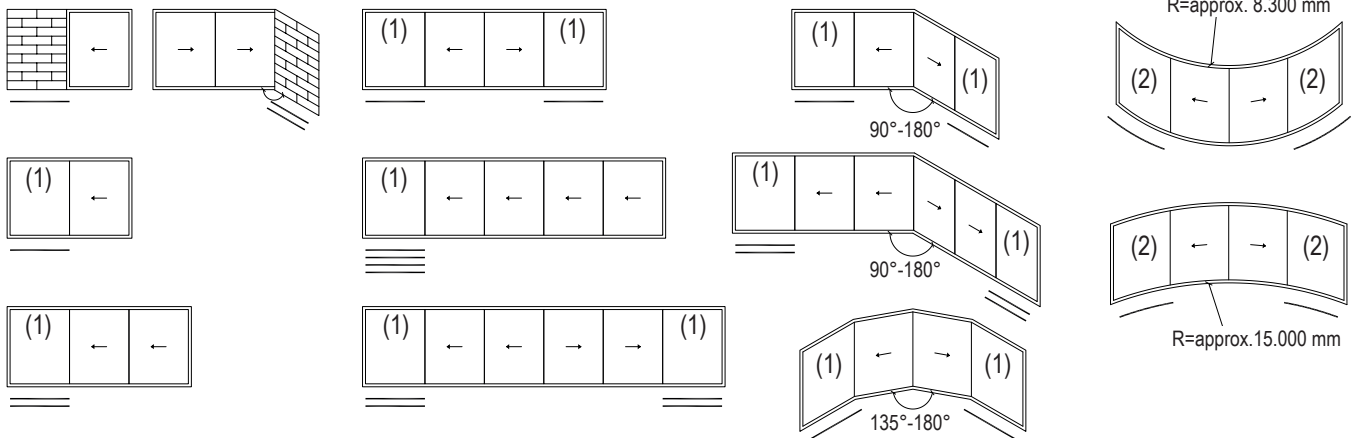

(1) Functions to be incorporated into target position

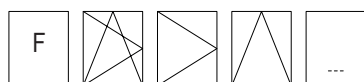

(2) Customized solution for target position possible

*** Total standard length of guiding rails is max. 6 m, any longer guiding rails can be customized

Dobler "Pop-in Window" in Detail

Parking positions - 3D modeling



Linear parking, partially open

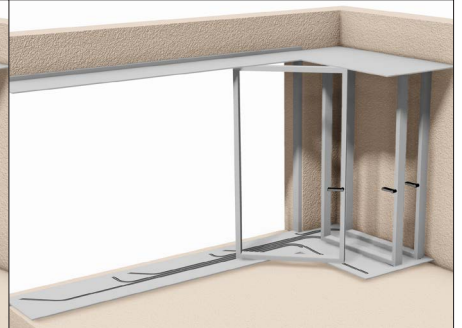
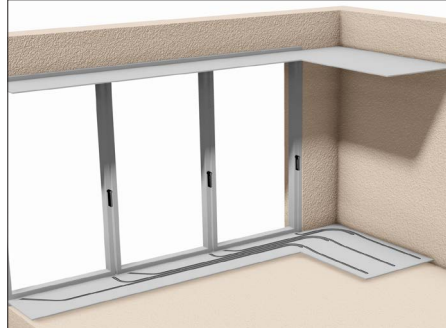

Orthogonal parking, closed/open

Views and cross sections of System S901 (Dobler Block System and barrier-free cross-sill)

Apart from the cross-sill there is no visual deviation between functional vent and fixed glass

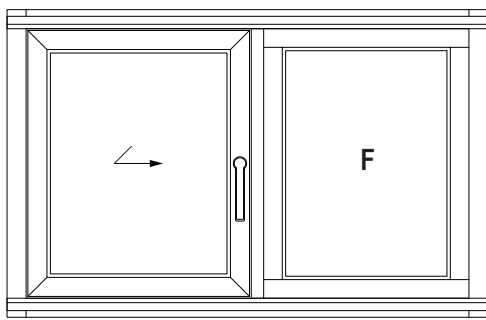

View from inside

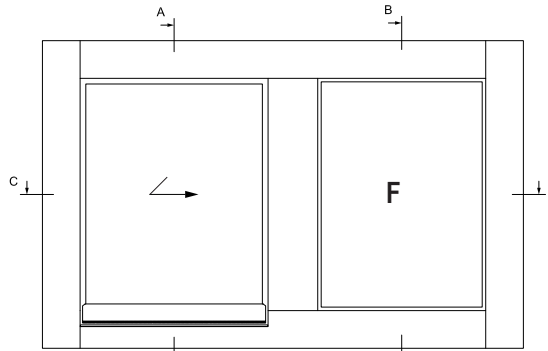

View from outside

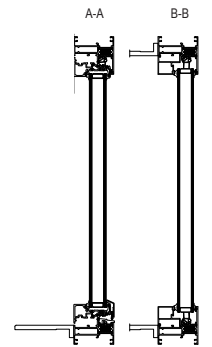

Vertical section

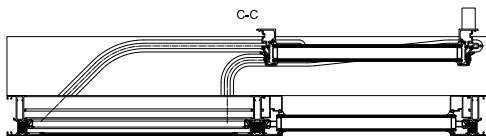

Horizontal section C-C, open vent

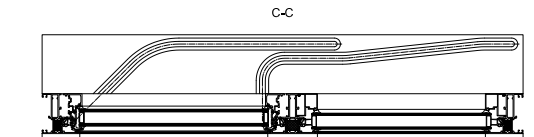

Horizontal section C-C, closed vent

Replaceable guiding rail possible in systems S901 / S104 / V104, up from a width of 350 mm this detail is mandatory

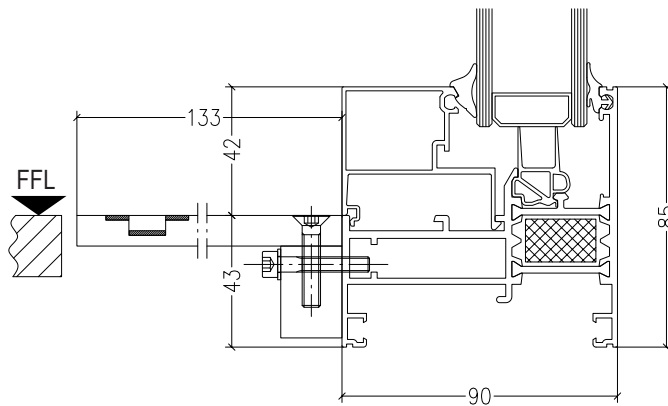

Cross section at fixed glass

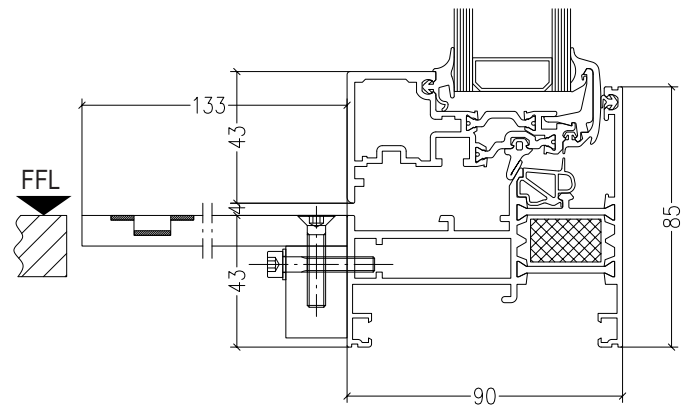

Cross section at vent

Dobler Pop-in Window in Detail

Barrier-free cross-sill

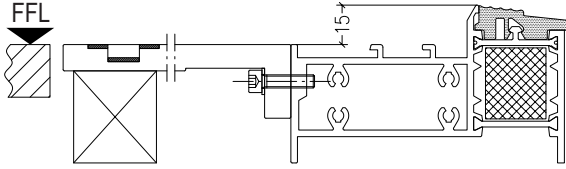

Barrier-free - height above FFL 15mm

Examples of realized barrier-free cross-sills

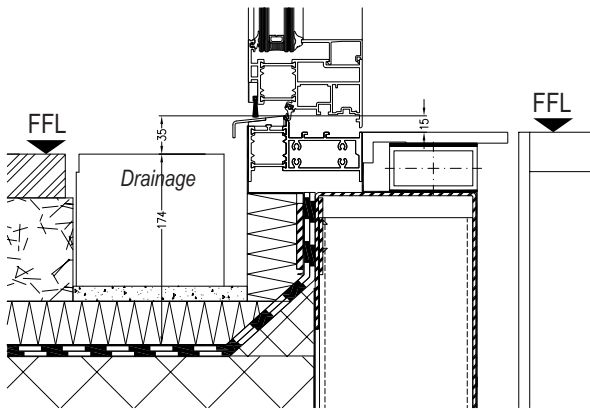

Vertical section - Bottom detail with drainage

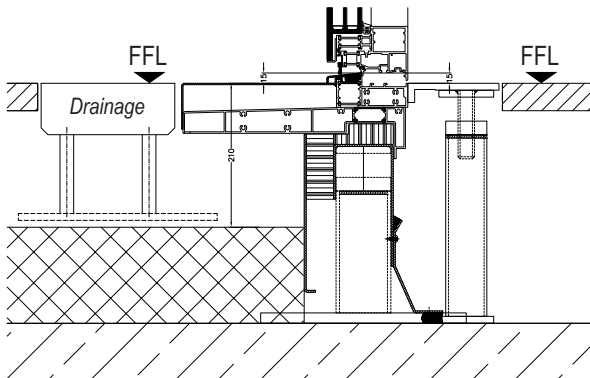

Vertical section - Bottom detail with drainage

Example of realized unitized curtain wall

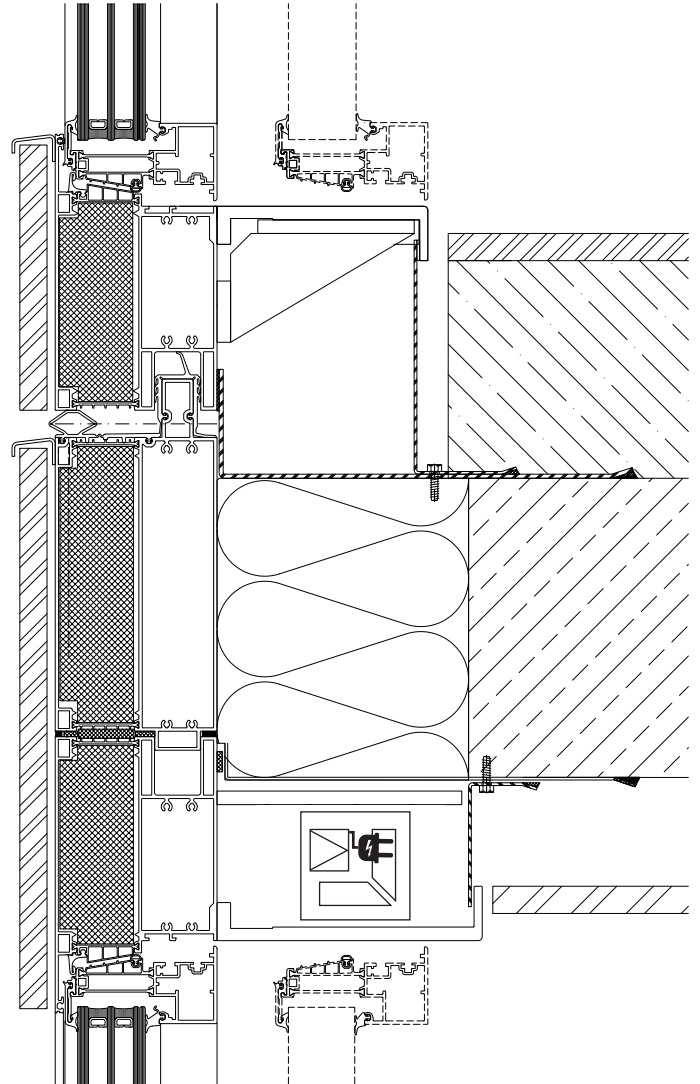

Vertical section - Dobler "Pop-in Window" used as a French window incl. glass balustrade incorporated into unitized curtain wall. Dead loads of CW elements are mounted at the bottom.

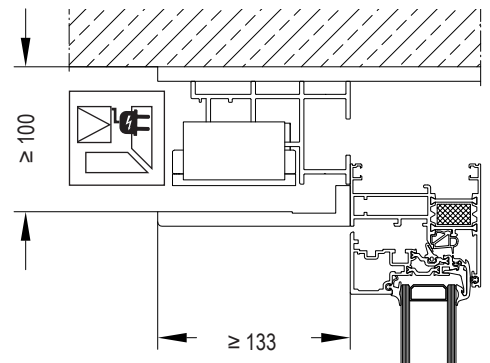

Vertical section - Dobler "Pop-in Window" with electric drive. Minimum dimensions of required free cavity above the guide rail.

Dobler "Pop-in Window" - Proven for Decades

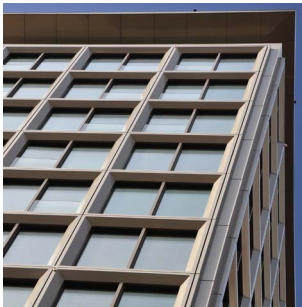

The Seven, Munich



Reichstag, Berlin



Bikini Haus, Berlin



Palazzo Mantegazza, Lugano

Fotograf: Franco Tessarolo



Villa, Aman



Sea Containers House, London

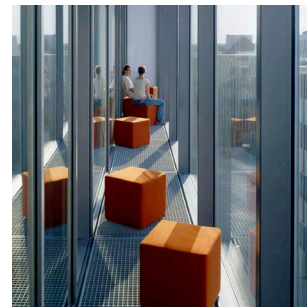

BMW-FIZ, Munich

Fotograf: H. G. Esch



Tower West, Liverpool

Fotograf: Infinite 3D

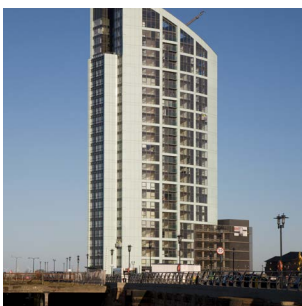

Alexandra Tower, Liverpool

Fotograf: Infinite 3D

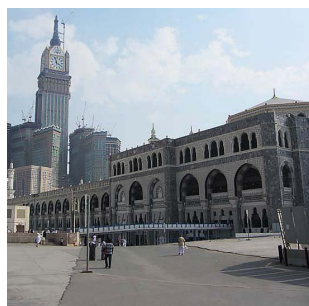

Holy Mosque, Mecca

Fotograf: Riva



Residential House



Residential House, Deggendorf

The Seven, Munich (Integrated in unitized CW) | **House of Parliament, Berlin** (Plenary hall, s/s guiding rail)
Bikini House, Berlin (9 vents in one unit) | **Palazzo Mantegazza, Lugano** (Radial design, SSG)
Tower West, Liverpool (High-rise building) | **Villa, Aman** (5 vents in one unit) | **Sea Containers House, London**
BMW-FIZ - Research and Innovation Centre, Munich (Electric drive) | **Holy Mosque, Mecca** (Guide groove crosswise)
Schwäbisch Hall Zentrale, Schwäbisch Hall | **Alexandra Tower, Liverpool** (High-rise building)
Central Bank Bavaria, Munich | **Monachia, Munich** | **Roche Tower, Basel** (Electric drive and Dobler BUS)
Quartermile, Edinburgh | **Christ Church Court, London** | **Atlantic House, London** | **Parliament View, London** | ...



Top detail - S901



Inner view polygonal design

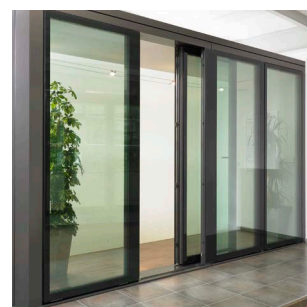

Forend in SGG-unit - V104

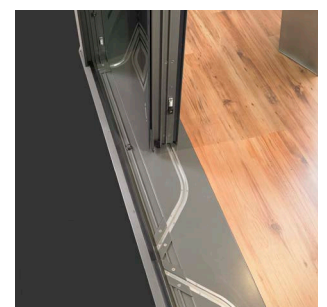

Bottom detail - polygonal design



DOBLER
METALLBAU

Dobler Metallbau GmbH
D-Deggendorf | D-München | D-Nürnberg | D-Wertingen

Dobler-MBM GmbH
D-Möckmühl

Dobler Stahl Glas GmbH
D-Augsburg

Dobler Metallbau s.r.o.
CZ-Nýrsko

Dobler Fassadenbau AG
CH-Zürich

Dobler UK Ltd
UK-London

Dobler BH d.o.o.
BIH-Sarajevo